



The Standards People



ETSI GANA Multilayer Autonomics & Multi-Layer AI Framework, and AN networks Stability:

Timescaling / Abstraction Levels for Control-Loops Designs and Implementation; Frameworks and Techniques for Addressing Stability and Coordination of Autonomic Functions (AFs) and their Control-Loops

Autonomic Management and Control (AMC) Paradigm

Presenters: Dr.-Ing. Ranganai Chaparadza; **Vodafone consultant/Capgemini Engineering**

Dr. Muslim Elkotob: Vodafone

Dr. Benoit Radier: Orange

Dr. Said Soulhi: Verizon

Multi-SDO Meeting Presentation

5th September 2022

ETSI GANA as a Holistic & Unifying Model for **AMC** (Autonomic Management & Control) that fuses together the well-established models for AMC:



(Reference : **ETSI TS 103 195-2**)

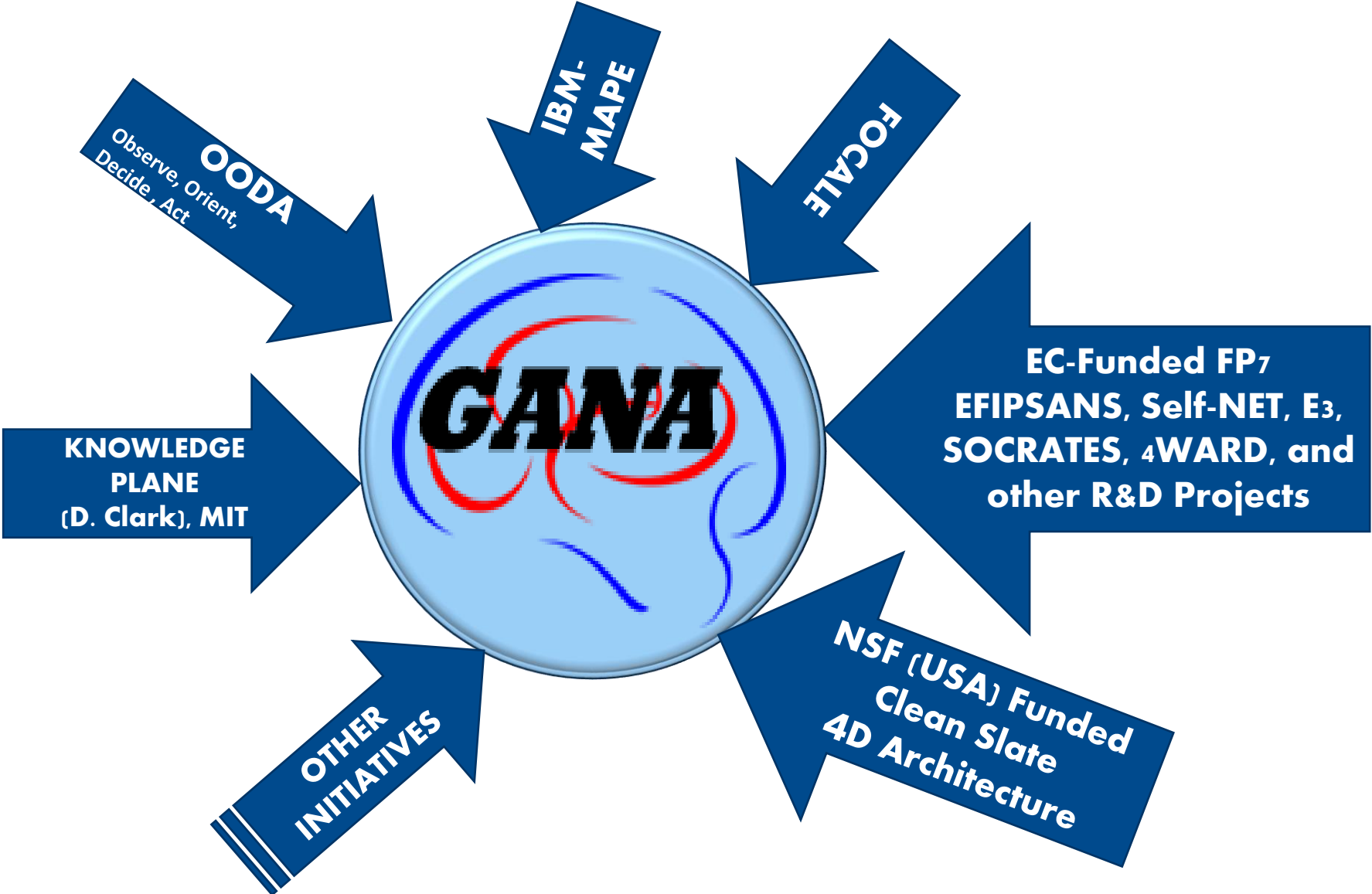

ETSI GANA (Generic Autonomic Networking Architecture)

Reference Model / Functional Architecture (ETSI TS 103 195-2) for Multi-Layer AI & AMC

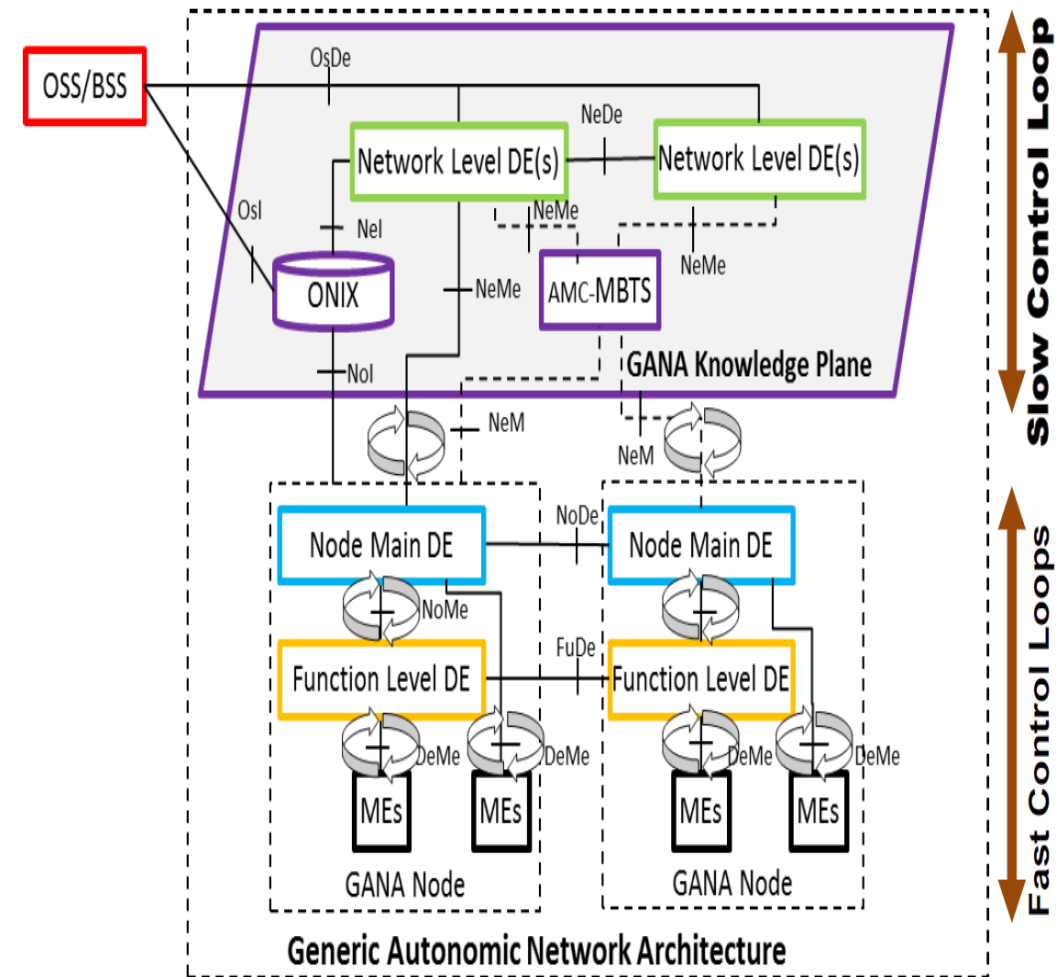
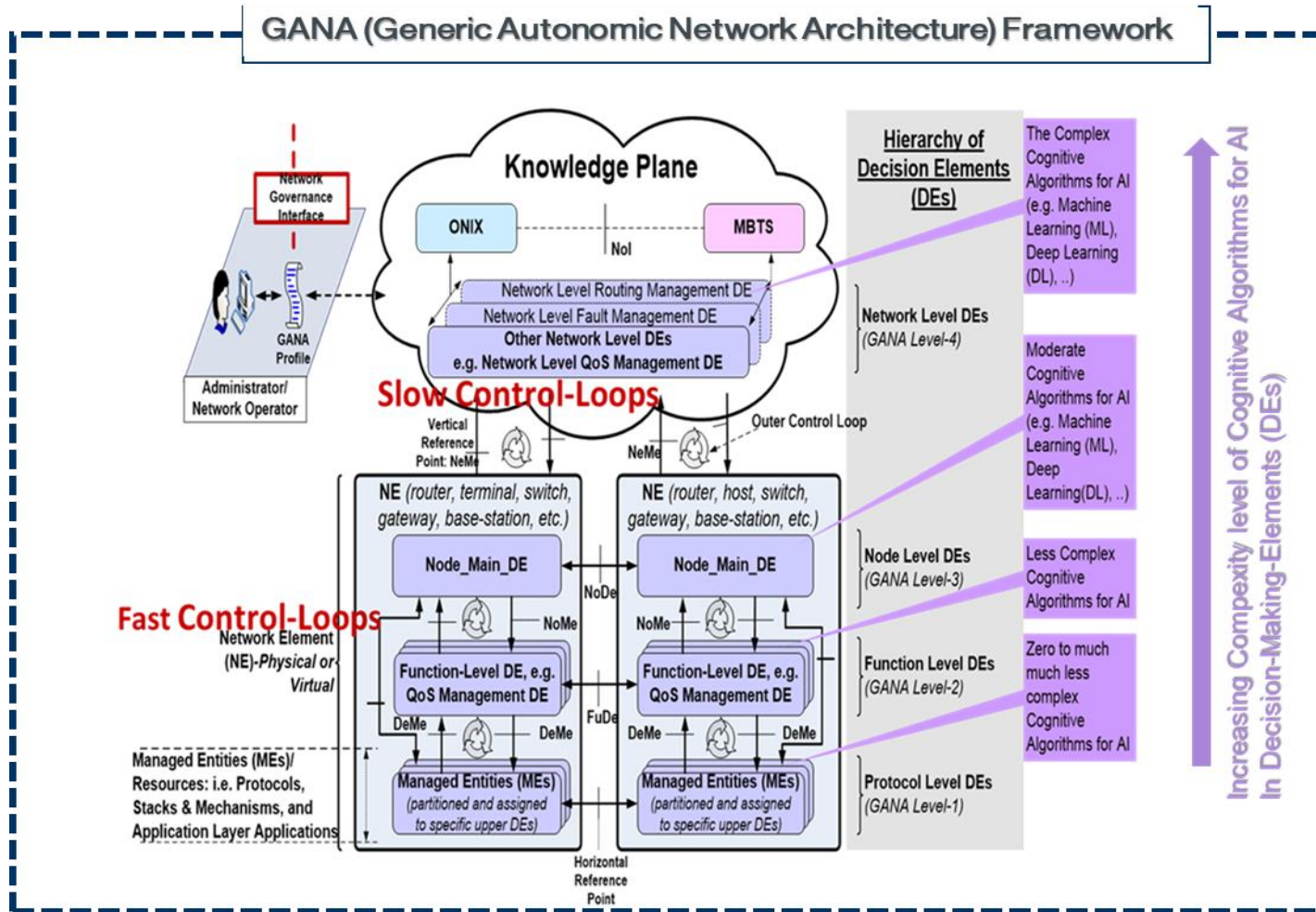

GANA is Framework for Multi-Layer Autonomic Management & Control (AMC)/Autonomics & Multi-Layer AI/ML for AMC

Remark: ETSI White Paper No.16 and ETSI TS 103 195-2 describe the Recommendation to focus on GANA levels 2 to 4 when introducing autonomics in architectures and Why

GANA in a Nutshell and Value of Autonomics designed and implemented at each GANA Level



❑ **GANA as a Multi-Layer AI/ML Framework**

- ❑ GANA is a a Multi-Layer AI/ML Framework for Autonomic Management & Control (AMC) of Networks and Services

❑ **GANA Knowledge Plane (KP) Platform**

- ❑ It is a Platform (with the much more complex AI/ML algorithms) that correlates events from multiple sources and implements Decision Elements (DEs) for dynamically planning and executing actions for the whole network in the long term as „Slow Control-Loops“ (Macro Autonomics), and has the intelligence on how to selectively use various means to program the network to achieve certain objectives accordingly

❑ **GANA DE (Decision making Element) or Autonomic Function (AF)**

- ❑ GANA defines and standardizes the various Autonomic Functions (i.e. Decision Elements (DEs)) a form of intelligence that can be instantiated in
 - ❑ certain NEs/NFs (Network Elements/Network Functions (PNFs or VNFs))
 - ❑ and GANA Knowledge Plane Platforms

❑ **GANA DEs introduced in the Nodes NEs/NFs**

- ❑ Also provide for a form of intelligence that helps reduce or limit the need for NEs/NFs to export huge amounts of Monitoring Data and Telemetry Data

❑ **AMC (Automic Management & Control) & AI**

- ❑ AMC is powered by AI Models and Algorithms employed by various GANA Deicion Elements (DEs) designed to operate at various levels of abstraction of autonomic/autonomous behaviour

GANA Hierarchical Control-Loops Main Interactions, and Value of Autonomics designed and implemented at each GANA Level



❑ **GANA Slow Control-Loops**

- ❑ are for the aspects that either are better addressed using centralized algorithms and Decision Making on the basis of the wider network scope, or should be addressed with long term planning for network programming of multiple NEs/NFs of a network segment that is under the responsibility of a specific Knowledge Plane (KP) Platform (e.g. KP for Core Network)

❑ **GANA Fast Control-Loops**

- ❑ are for aspects that require fast reaction within certain Network Elements/Functions (NEs/NFs).
- ❑ and the associated AI algorithms & Cognition introduced in NE/NFs are less complex than those in the GANA Knowledge Plane (KP) Platform

❑ **GANA Slows Control-Loops of the KP Platform policy-control the Fast Control-loops in NEs/NFs:**

- ❑ **Fast Control Loops** operate in NEs/NFs (by GANA Levels 2 & 3 DEs implemented in the NEs/NFs)

❑ **Main Interactions between GANA Control-Loops**

- ❑ Vertical, Horizontal interactions, Coordination, Orchestration, Synchronisation, Policy-Controlling, „DE Ownership of ME(s)“ Concept and mapping table for per design Conflict Prevention

GANA as a Hybrid Model for Multi-Layer Autonomics and associated Multi-Layer AI Algorithms



❑ GANA is a Hybrid Model

- ❑ It guides and offers flexibility to implementers on the choice to implement certain autonomics as distributed software and algorithms within certain Network Elements/Functions (NEs/NFs), i.e. „**Micro Autonomics**“, while being able to also choose to implement some algorithms as centralized algorithms in the KP Platform („**Macro Autonomics**“)

❑ Hybrid SON Model is compatible with GANA

- ❑ Hybrid SON (C-SON(**Centralized SON**) & DSON(**Distributed SON**)) are considered as an implementation of the GANA Model for the RAN

Hybrid-SON Model Mappings to the ETSI GANA Model

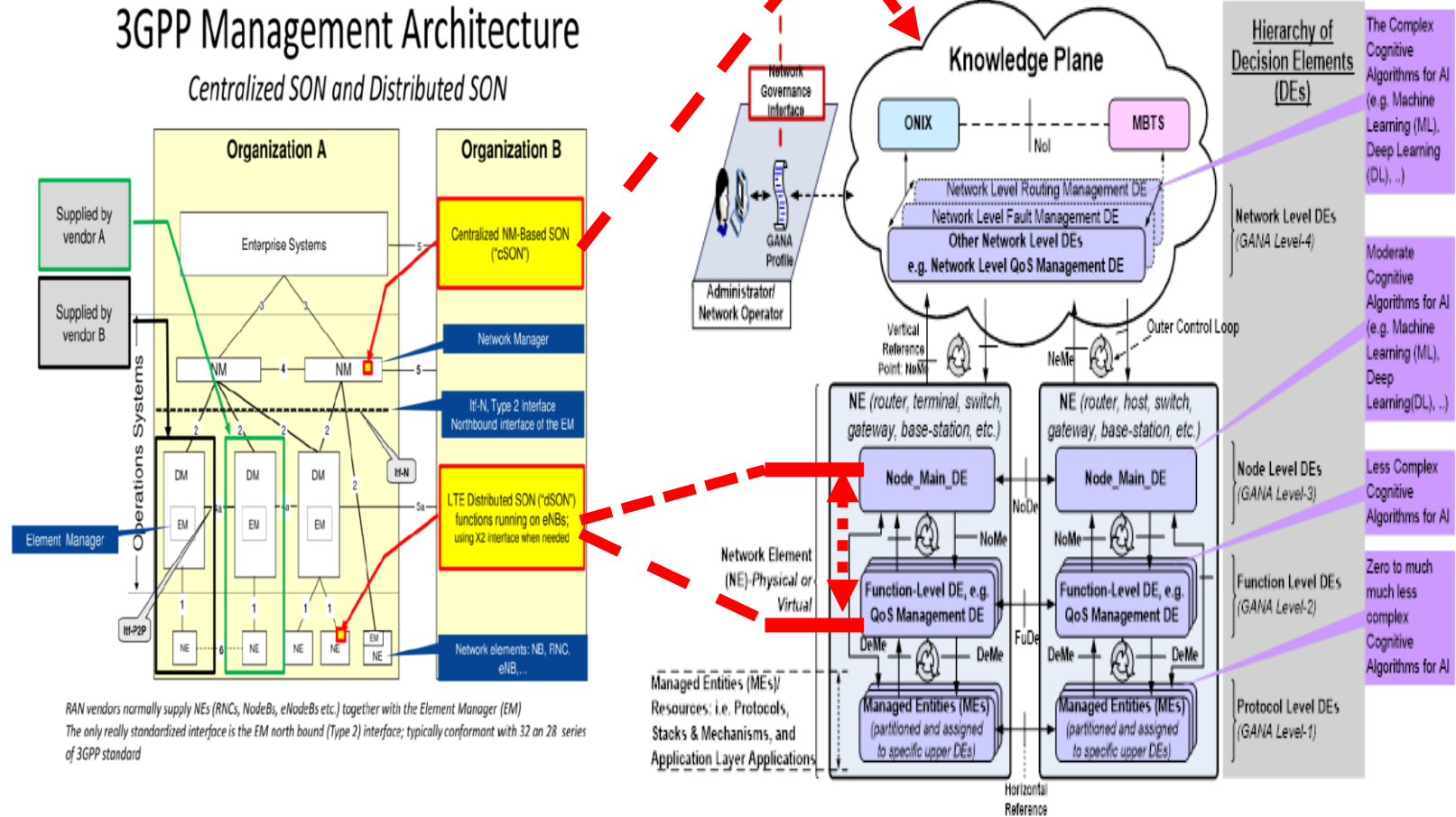

GANAs for the RAN is realized by Hybrid SON (C-SON (cognitive) complemented by D-SON in eNBs)
SON Function = GANA Decision Element (DE)
C-SON with Cognitive SON Functions = GANA Knowledge Plane for the RAN

Example “instantiation” of GANA DE(s) for Autonomic management and Control for Routing Protocols/Mechanisms)

This *cloud* represents an overlay or logically centralised DE(s)

- (1) With wider network-wide view to perform sophisticated decisions e.g. network optimization.
- (2) Centralized to either avoid processing overhead in managed nodes or scalability and/or complexity problems with distributed decision logic for network elements
- (3) The Elements in this cloud may be the ones that provide an *interface* for a humans to define Goals and Objectives or Policies e.g. Business Goals

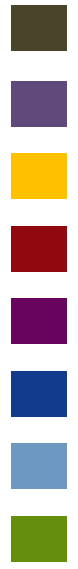
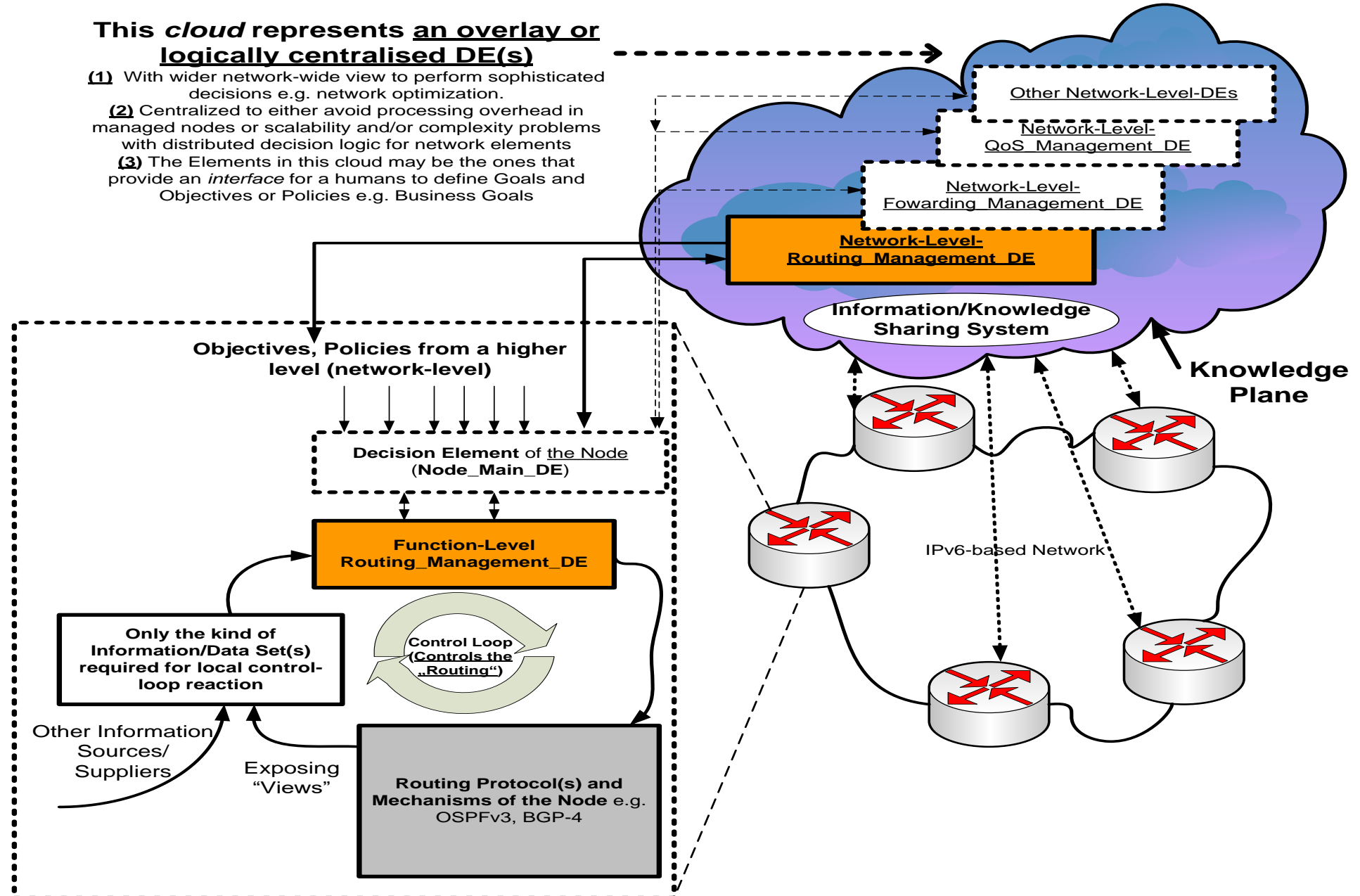

ETSI TS 103 195-2 provides DE-to-its Managed Entities (MEs) Mappings to Guide Implementations of DEs and Control-Loops



Network-Level DEs	Node-Level DEs	Function-Level DEs	Protocols and Mechanisms as Managed-Entities (MEs)	Examples of protocols and Mechanisms that are mapped as MEs
	GANA NODE			
NET_LEVEL_SEC_M_DE	NODE_LEVEL_SEC_M_DE		Security Protocols, Algorithms and Mechanisms	Certificates/Passwords Algorithms, Hash Algorithms, Encryption Algorithms, Access Control Mechanisms, Trust Mechanisms, Denial of Service (DoS) Detection/Prevention algorithms/mechanisms, Signature based intrusion detection mechanisms, etc.
NET_LEVEL_FM_DE	NODE_LEVEL_FM_DE		Fault Detection Mechanisms, Fault Isolation/Localization/Diagnosis Mechanisms, Fault Removal Mechanisms	Active Probing mechanisms, Bi-Directional Forwarding Detection (BFD protocol) for link failure detection, Self-test/diagnose functions, rebooting, reloading, automated module replacement mechanisms, etc.
NET_LEVEL_RS_DE	NODE_LEVEL_RS_DE		Proactive and Reactive Resilience Mechanisms, Survivability Strategies and Algorithms, Restoration and Protection Mechanisms	Node Resilience mechanisms, and Network Resilience mechanisms, etc.
	NODE_LEVEL_AC_DE		Neighbour Discovery Protocols/Mechanisms and Network Discovery Mechanisms	Neighbour Discovery Protocol (NDP), Secure Neighbour Discovery Protocol (SEND), etc.
NET_LEVEL_RM_DE		FUNC_LEVEL_RM_DE	Routing Protocols and Mechanisms	OSPF, BGP, RIP, ISIS, etc.
NET_LEVEL_FWD_M_DE		FUNC_LEVEL_FWD_M_DE	Layer-3 Forwarding Protocols and Mechanisms, Layer-2.5-Forwarding, Layer-2-Forwarding, Layer-3-Switching, Layer-2-Switching, etc.	IPv4/IPv6 Forwarding Engine, Multi-Protocol Label Switching (MPLS), etc.
NET_LEVEL_QoS_M_DE		FUNC_LEVEL_QoS_M_DE	QoS Protocols and Mechanisms	Packet classifier, Packet Marker, Queue Management, Queue Scheduler, RSVP, etc.
NET_LEVEL_MOM_DE		FUNC_LEVEL_MOM_DE	Mobility Management Protocols and Mechanisms	Mobility Support in Internet Protocol Version 6 (MIPv6), Datagram Congestion Control Protocol, Mobile Stream Control Transmission Protocol, Site Multi-homing by IPv6 Intermediation, Proxy-Mobile-IP, Mobility-Management User-Equipment Managed-Entity, Measurement-Report-Function Managed-Entity, Candidate-Access-Router-Discovery mechanism, Fast Handover Scheme, Policy Control and Charging Rules Function mechanism, etc.
NET_LEVEL_MON_DE	NODE_MAIN_DE	FUNC_LEVEL_MON_DE	Monitoring Protocols, Mechanisms and Tools	IPFIX data collection and dissemination mechanisms, SNMP data collection and dissemination mechanisms, NETFLOW data collection and dissemination mechanisms, Protocol Analysers, Packet Trace creation and dissemination mechanisms. Effective and Available Bandwidth Estimation mechanisms, IPv6 hop-by-hop options for intrinsic monitoring, etc.
		FUNC_LEVEL_SM_DE	Services and Applications	Orchestration of services, service-discovery, interpretation of service and application requirements at run-time and requesting the network layer to behave in a service/application-aware manner, realizing a control-loop over the services/applications as its Managed Entities (MEs), collaboration with other DEs of responsible of autonomic management of the network layer protocols in order to realize collaborative self-adaptation on both the service-layer and the network-layer.

NOTE: There are other DEs that may have not been included in the Table 3 and implementers should take them into account based on their descriptions provided in the present document. Such DEs include Network-Level-Generalized Control Plane-Management-DE (NET-LEVEL-GCP_M_DE), Function-Level-Generalized Control Plane-Management-DE (FUNC-LEVEL-GCP_M_DE), Network Level End-to-End “end-user oriented” Service and Applications Management (NET_LEVEL_E2E_Service_M)

ETSI GANA Multi-Layer Autonomics with Multi-Layer AI and Knowledge Plane(KP) Platform Integration with other Systems

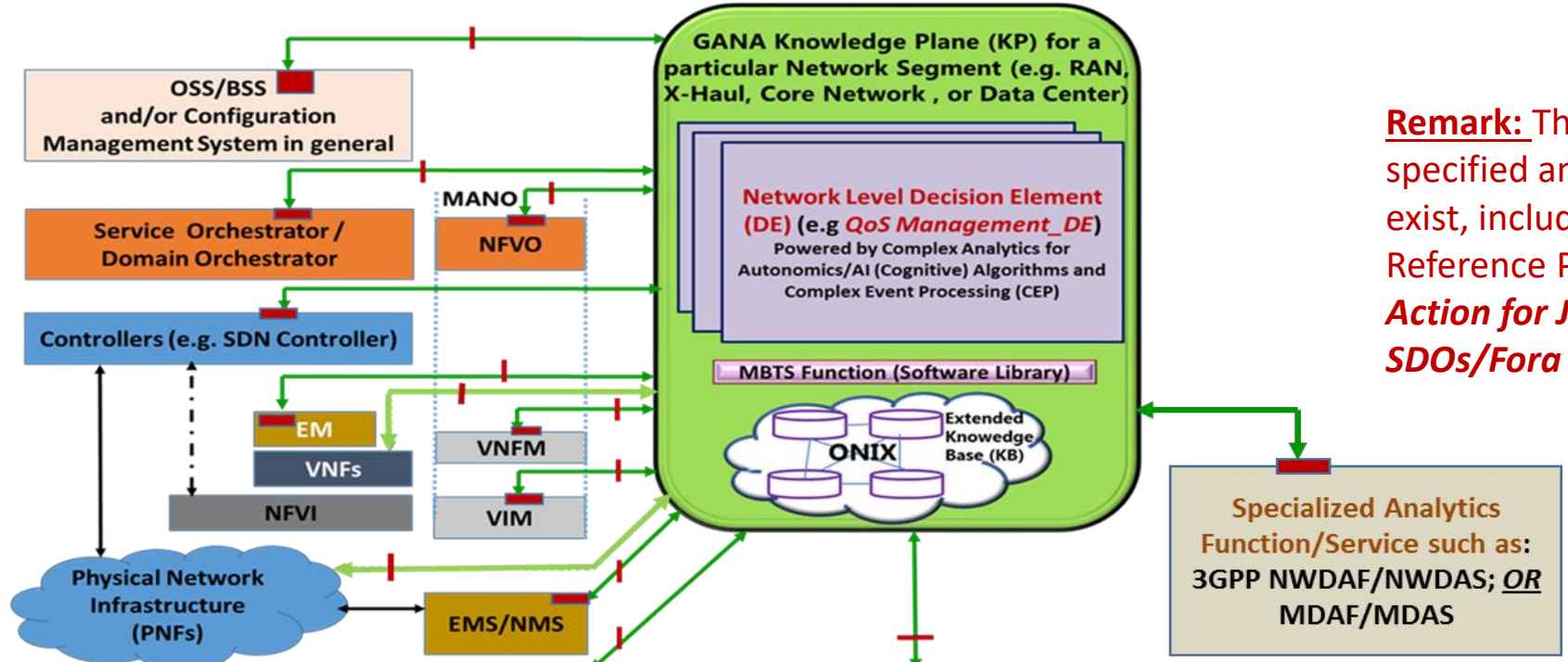

Remark: The NBI APIs indicated should be specified and Standardized if no standards exist, including KP-to-KP Federation Reference Points. → *Implies a Call for Action for Joint efforts by Standards SDOs/Fora*

Legend:
 ■ = NBI (NorthBound Interface) implemented as an API (e.g. RESTful API) or Protocol. The GANA KP uses the NBI exposed by the entity to program the network or services, or to configure the entity to export Data, Info, Knowledge, or Events to the GANA KP or other consumers

Certain Big-Data Applications & other Applications (e.g. Optimization Apps) that should interwork with the KP or can be invoked by KP— *if such Applications couldn't be implemented as integral parts of the KP* (either as embedded parts of DE logic or as Analytics Modules commonly shared by the multiple KP DEs)

Other Types of Data/Info/Knowledge Sources & Event Sources:

- Meta-Data from NEs/NFs; Syslog; SNMP; NetFlow/IPFIX/sFlow; Telemetry Data; Fault-Management (FM) and Performance Management (PM) Systems; Configuration Management (CM) Platform; Trouble Ticket Systems; Data Collectors; Topology Info; HealthScores Data; Config-Data; Service Definitions and any mappings to QoS Classes, SLA Definitions & Customer Identifiers Info/Data; Other Data/Info Sources;

ETSI TR 103 747

Framework for Addressing Stability of Control-Loops in GANA: Design for Stability Principles and Run-Time Stability Principles for *Coordination / Synchronization / Orchestration among DEs*



One of the Principles for Addressing Stability specified in GANA (DE-to-DE Coordination)

Intent translated into Goals and Policies. It resolves conflicts

Intent Specification (Should be provided as input to the GANA Knowledge Plane (KP) primarily rather than at NE level) by the CSP

Governance Interface CSP

Each DE can be designed to derive and compute from Intent, Goals and Policies Intended for its scope

GANA Knowledge Plane Level
 AutoDiscovery_ & AutoConfiguration-DE
 (GANA_KP -DE / AI Model)
 Superior/Designated cDE

GANA Knowledge Plane Level
 Security-Management-DE
 (ODAS_KP Sec Mgt DE / AI Model)

GANA_KP Level DE
 « x » e.g. Mobility-Management-DE

GANA_KP Level DE « z »
 e.g. Routing-Management-DE

GANA_KP Level DE « y »
 e.g. QoS-Management-DE

DE-to-DE Coordination

- 1) Act as Orchestrator Role besides Coordinator
- 2) Employ Optimisation Algorithm To ordering of certain Actions or Plans of Actions computed by the DEs it coordinates, before DEs are allowed to execute the Actions

DE-to-DE Collaboration in form of a Chereography, by exchange of information and or negotiations on parameter values adjustments on the policies they enforce in order to achieve the High Level (e.g. ODA Level) Global Autonomics and AI Objective

ETSI GS AFI 002 & ETSI TS 103 195-2 present, in general, Framework for Addressing Stability of Control-Loops and Coordination of Autonomic Functions (e.g. GANA DEs)



- ❑ **Stability Issues in Autonomic Networking (AN)**
- ❑ Designing for Stability (Design for Stability Principles)
- ❑ Stable Autonomic Behaviors Design through Game Theory - From Theory to Theory
- ❑ How to Treat Stability via Analytical Methods? - A Game Theoretic Approach
- ❑ How to address stability via Game Theory?
- ❑ Addressing Stability in an Architectural Level - From Theory to Practice
- ❑ Hierarchy of Control-Loops (DEs)
- ❑ Concept of "Ownership" in relationship between Autonomic Function & Managed Entity (ME)
- ❑ Separation of "Operating Regions" of Control-Loops
- ❑ Model-based Techniques
- ❑ Addressing Stability at Runtime
- ❑ Autonomic-aware Metrics to Infer and Self-assess Stability by the AN on its own

GANA Knowledge Plane (KP) for RAN as RIC/xApps/rApps Framework for O-RAN case, and as C-SON for the traditional RAN case; and E2E GANA KPs Platforms Federations → Ongoing Study in ETSI TR 103 858

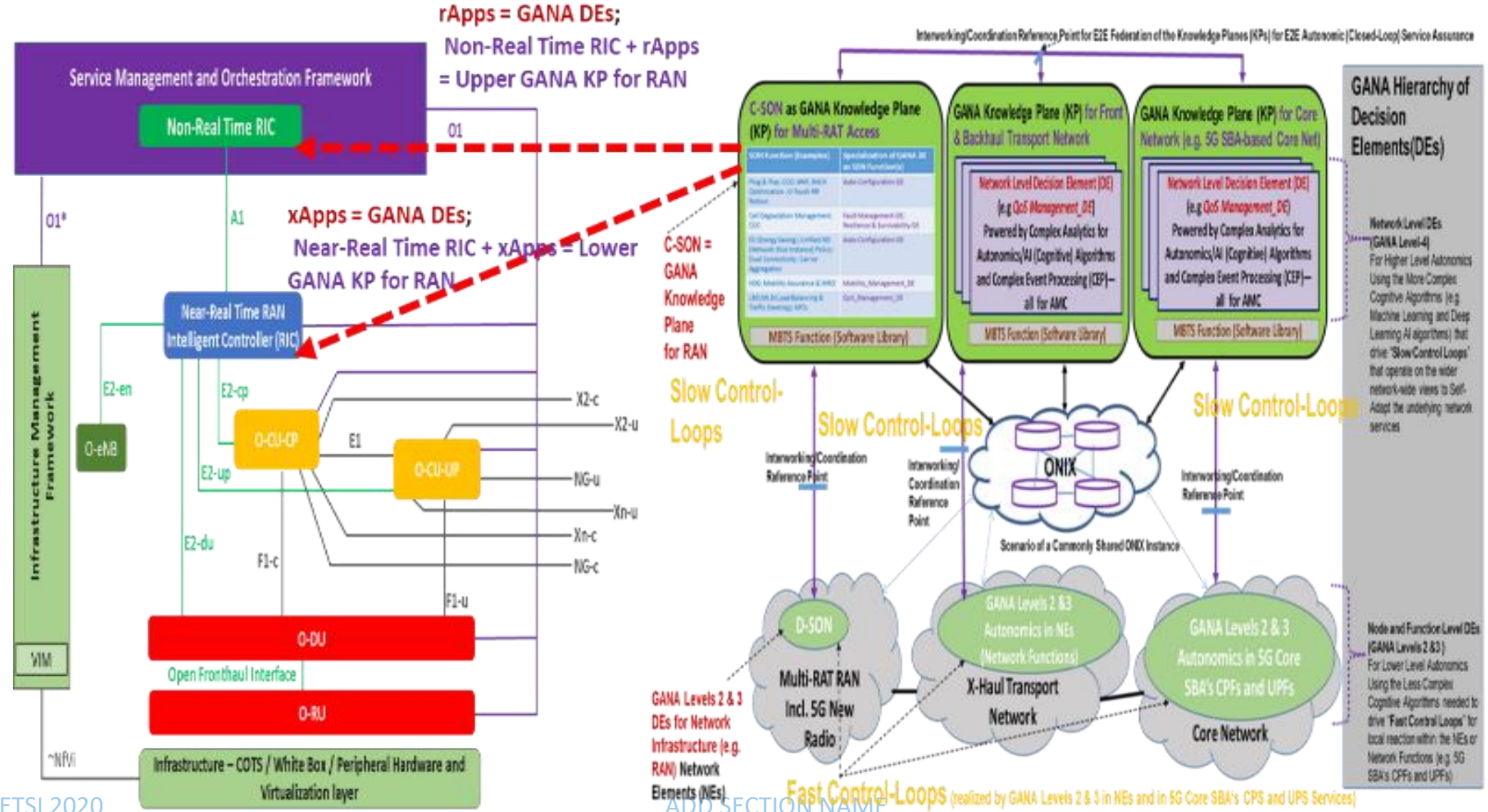

ETSI TC INT AFI WG Collaborations with other SDOs/Fora on GANA

Multi-Layer Autonomics with Multi-Layer AI

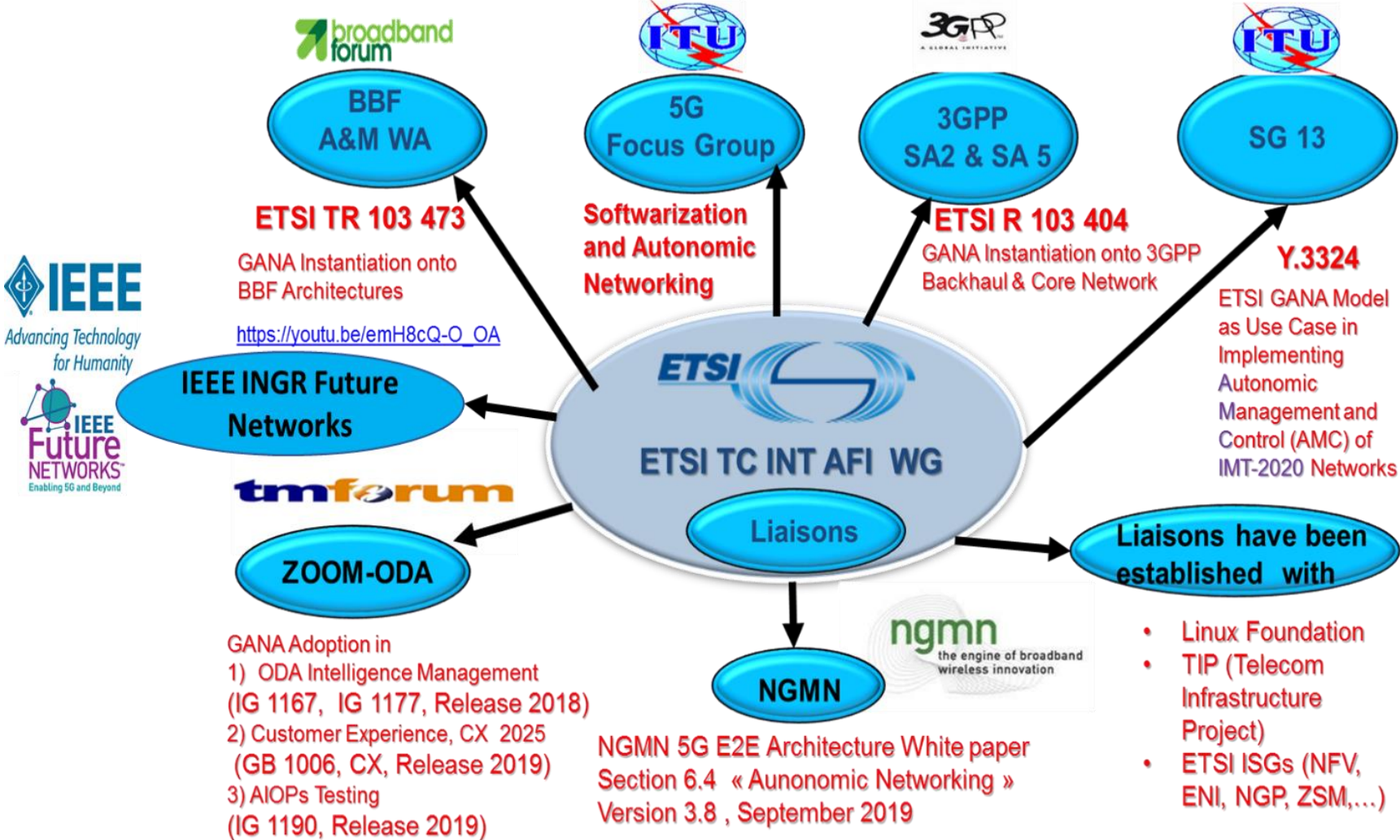

Automated Intelligent Management (AIM) - overview

- In Broadband Forum (BBF)
- Access & Home Network O&M Automation/Intelligence
 - Not necessarily AI/ML
 - Work with Network Functions Virtualization (NFV) & equipment disaggregation
- Project phases
 - Key use cases
 - Logical framework
 - **TR-436**, Access & Home Network O&M Automation/Intelligence
 - Approved for publication
 - Builds on ETSI Generic Autonomic Networking Architecture (GANA) framework, also ML pipelines from ITU-T Y.3172, and TM Forum Open Digital Architecture (ODA)
 - Aligns with Broadband Forum CloudCO specs
 - Data models & interfaces
 - Now starting

ETSI GANA Model Adoption in BroadBand Forum (BBF)'s AIM Framework



AIM pipeline

- Inspired by ITU-T Y.3172, Architectural framework for machine learning (ML) in future networks including IMT-2020

AIM pipeline representation

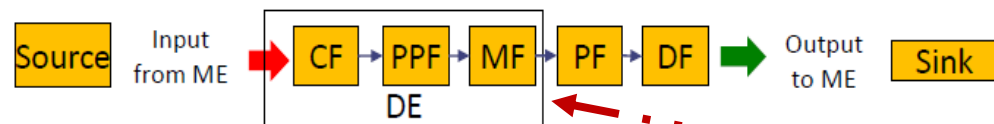

- Collection Function (CF): responsible for data collection
- Pre-processing Function (PPF): responsible for data processing
- Model Function (MF): responsible for knowledge handling, can use AI / ML
- Policy Function (PF): responsible for the application of policies to the MF outputs
- Distributor Function (DF): responsible for distributing the outputs of the MF

DE design with Pipelines

- Other pipelines examples:

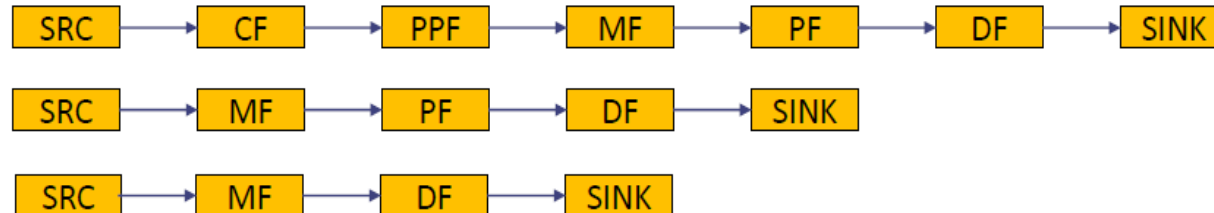

ODA Intelligence Management GB1022 adopted ETSI GANA design principles

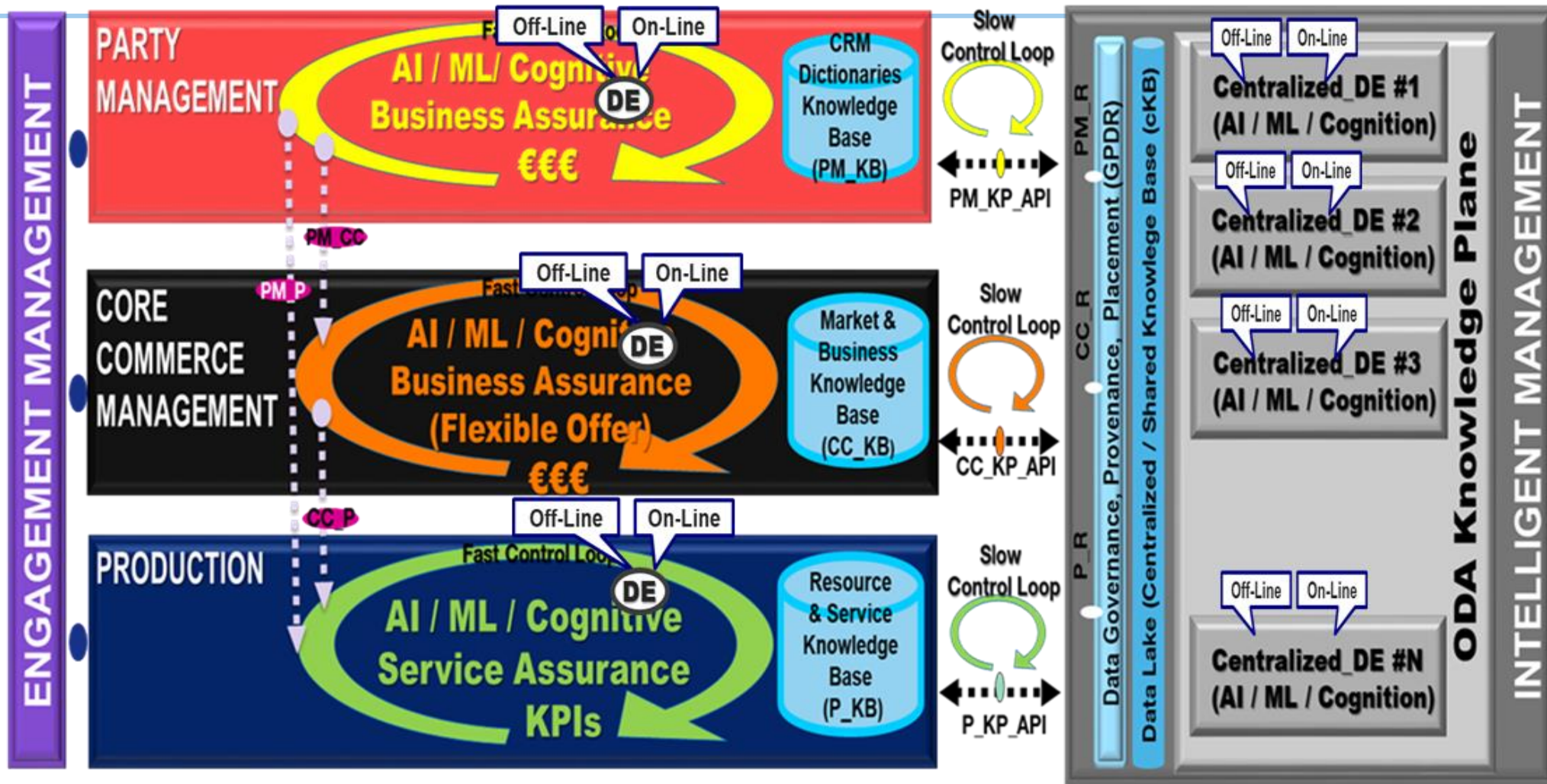

TMForum AN Reference architecture should align with ODA Intelligence Management

Thank you